



# SPECIFICATION

## Surface Acoustic Wave Filter

- **Application : WCDMA DPX (LTE Band 1 )**
- **Model : SFXG50EY902**
- **Center Frequency : 1950.0 / 2140.0 [MHz]**



**WISOL CO., LTD.**

531-7, GAJANG-RO, OSAN-SI,  
GYUNGGI-DO, KOREA, 18103

<http://www.wisol.co.kr>

购买原装正品请认准-德方电子  
免费服务热线: 400-655-8700  
深圳总部电话: 0755-28187877  
网址: [www.denovocn.com](http://www.denovocn.com)

# 1. OUTLINE DRAWING & RECOMMENDED PCB

< Outline Drawing >

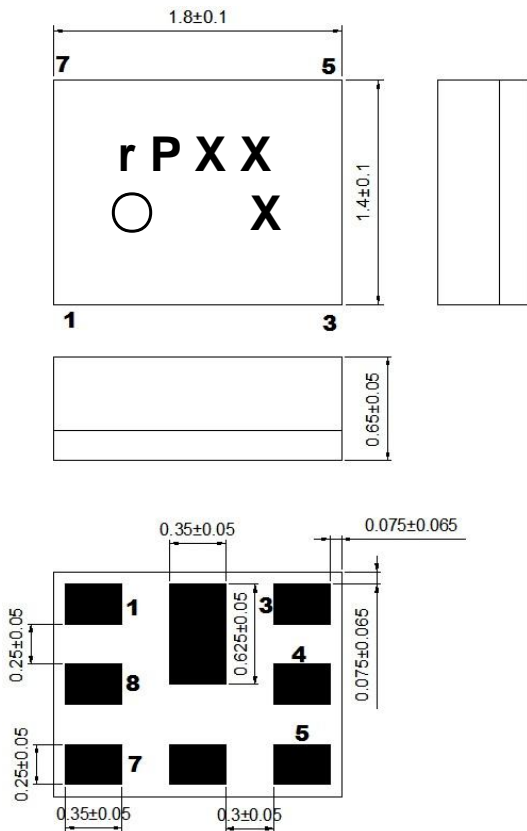

<Recommended PCB>

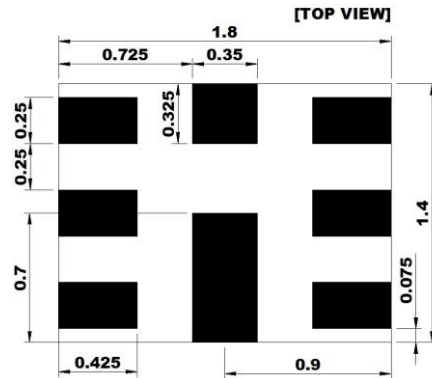

No.	Function
1, 8	Rx Output
3	Tx Input
6	Antenna
2, 4, 5, 7	GND

[Unit: mm]

# 2. TEST FIXTURE

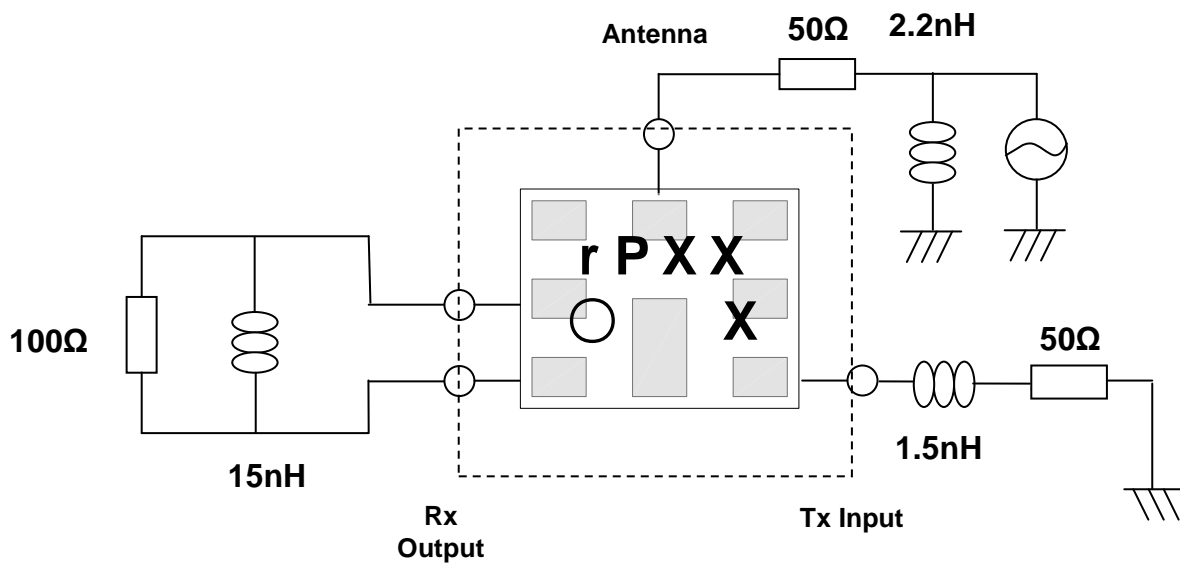

< Top View >

### 3. PERFORMANCE

#### 3-1. MAXIMUM RATINGS

CHARACTERISTICS	RATINGS	UNITS
DC Permissive Voltage	5	V
Maximum Input Power	0.8	W
Operating Temperature Range	-30 ~ +85	°C
Storage Temperature Range	-40 ~ +85	°C

#### 3-2. ELECTRICAL CHARACTERISTICS

##### 3-2-1. TABLE

Ta = -30 ~ +85°C

Item	CONDITION [MHz]	UNIT	RATING		
			Min.	Typ.(25°C)	Max.
<b>TX → ANTENNA</b>					
Insertion Loss	1920 ~ 1980	dB	-	1.3	1.9
Inband Ripple	1920 ~ 1980	dB	-	0.3	1.0
VSWR(Tx)	1920 ~ 1980	-	-	1.7	2.2
VSWR(Ant)	1920 ~ 1980	-	-	1.6	2.0
Absolute Attenuation	1 ~ 410	dB	45	53	-
	420 ~ 494	dB	42	50	
	843 ~ 894	dB	37	41	
	1565.42 ~ 1573.374	dB	34	38	
	1573.374 ~ 1577.466	dB	34	38	
	1577.466 ~ 1585.42	dB	34	38	
	1597.5515 ~ 1605.886	dB	35	38	-
	1605.886 ~ 1805	dB	28	36	-
	1805 ~ 1880	dB	20	31	-
	2010 ~ 2040**	dB	15	23	
	2110 ~ 2170	dB	40	44	
	2400 ~ 2500	dB	33	37	
	2620 ~ 2690	dB	29	33	
3840 ~ 3960	dB	21	26		
5150 ~ 5940	dB	15	20		
Termination Impedance : Tx / ANTENNA			50Ω(1.5[nH])/ 50Ω(// 2.2[nH])		
<b>ANTENNA → RX</b>					
Insertion Loss	2110 ~ 2170	dB	-	1.6	2.1
Inband Ripple	2110 ~ 2170	dB	-	0.3	1.0

VSWR(Rx)	2110 ~ 2170	-	-	1.5	2.0
VSWR(Ant)	2110 ~ 2170	-	-	1.3	2.0
Absolute Attenuation	1 ~ 1920	dB	40	45	-
	1920 ~ 1980	dB	53	63	-
	1980 ~ 2025	dB	30	46	-
	2255 ~ 2400	dB	15	34	-
	2400 ~ 2484	dB	32	37	-
	2484 ~ 3200	dB	28	33	-
	3200 ~ 6000	dB	47	54	-
Termination Impedance : ANT / Rx			50Ω(//2.2[nH]) / 100Ω(//15[nH])		
TX → RX					
Isolation between Rx and Tx	1920 ~ 1980	dB	55	61	-
	2110 ~ 2170	dB	50	56	-
	1574 ~ 1577	dB	60	68	-
	3840 ~ 3960	dB	56	64	-
	4220 ~ 4340	dB	58	67	-

※ Note : Excluding losses due to PCB

\*\* TX→ANTENNA Absolute Attenuation(2010~2040 MHz) : 15~85℃

### 3-2-2. GRAPH

Tx→Ant, Ant→Rx Transmission Characteristics

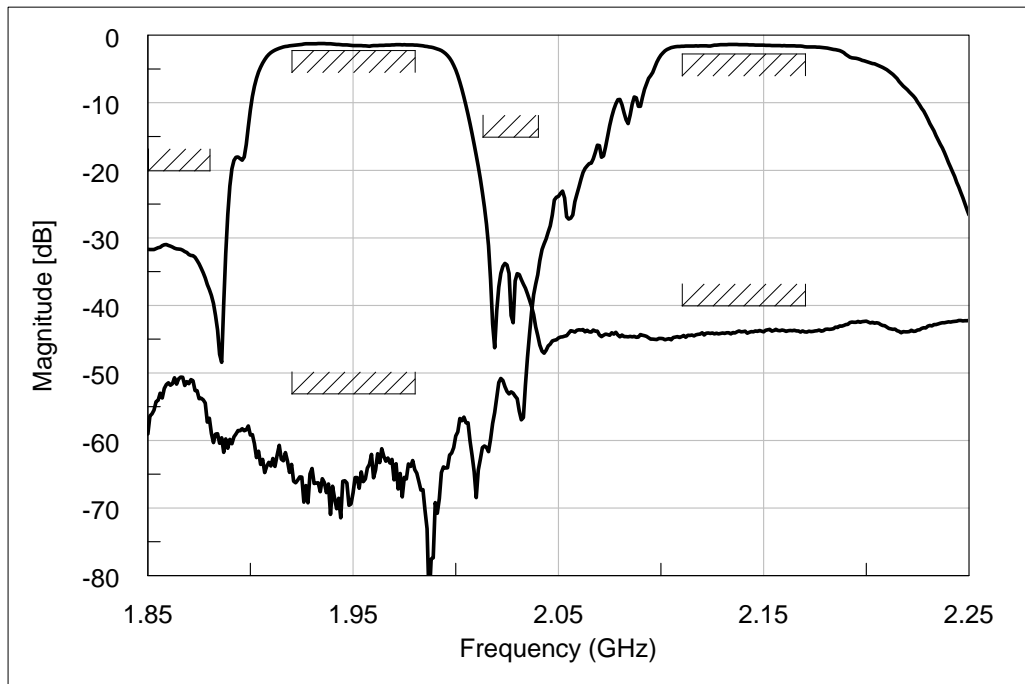

### Tx→Rx Isolation Characteristics

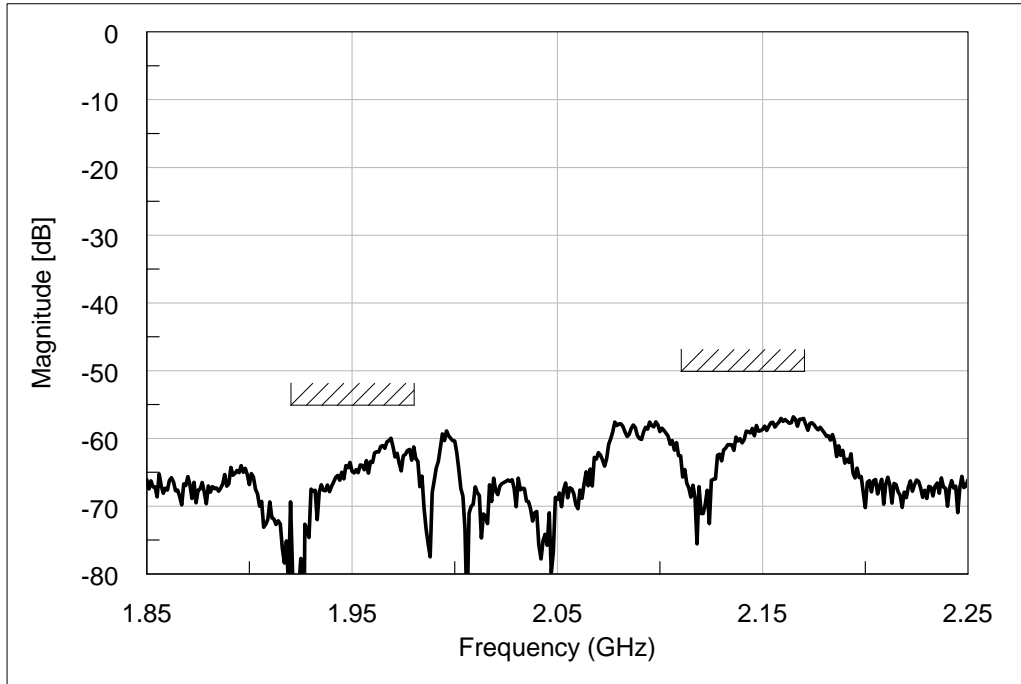

### Tx→Ant Transmission Characteristics (Full band)

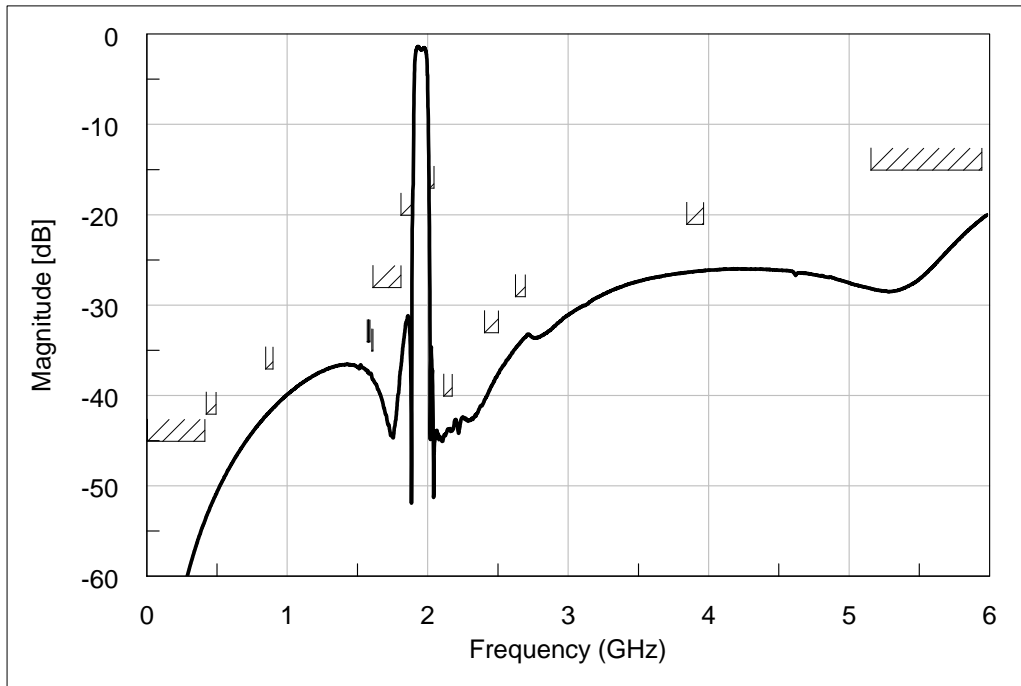

### Ant→Rx Transmission Characteristics (Full band)

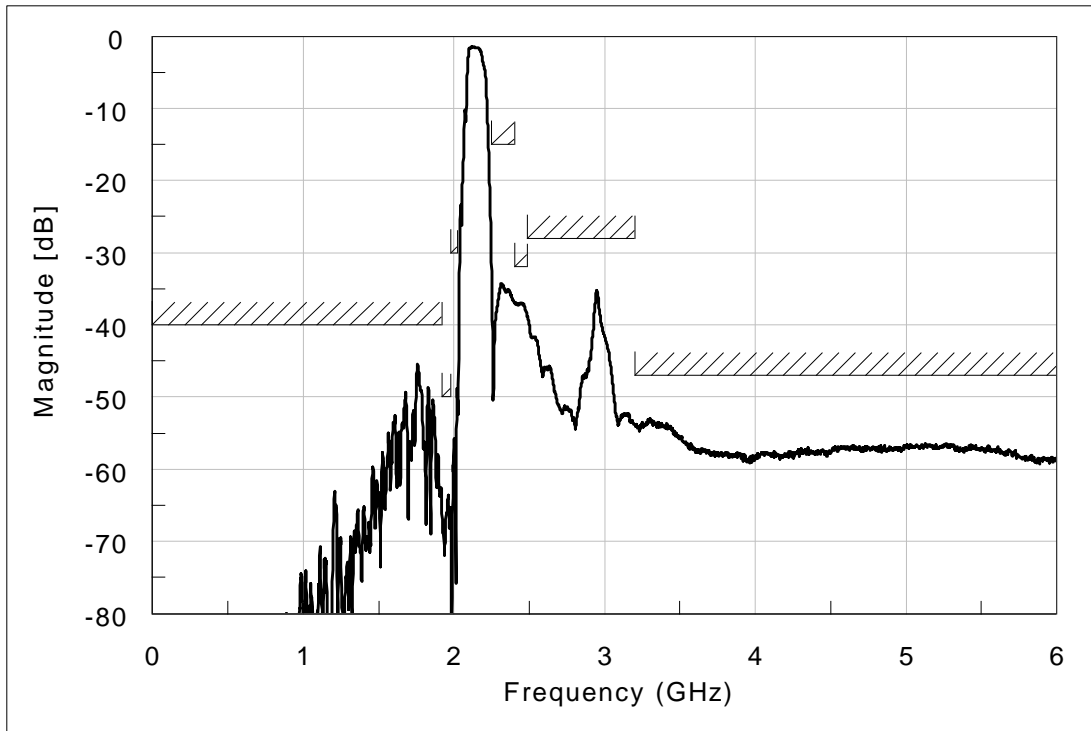

### Ant Smithchart

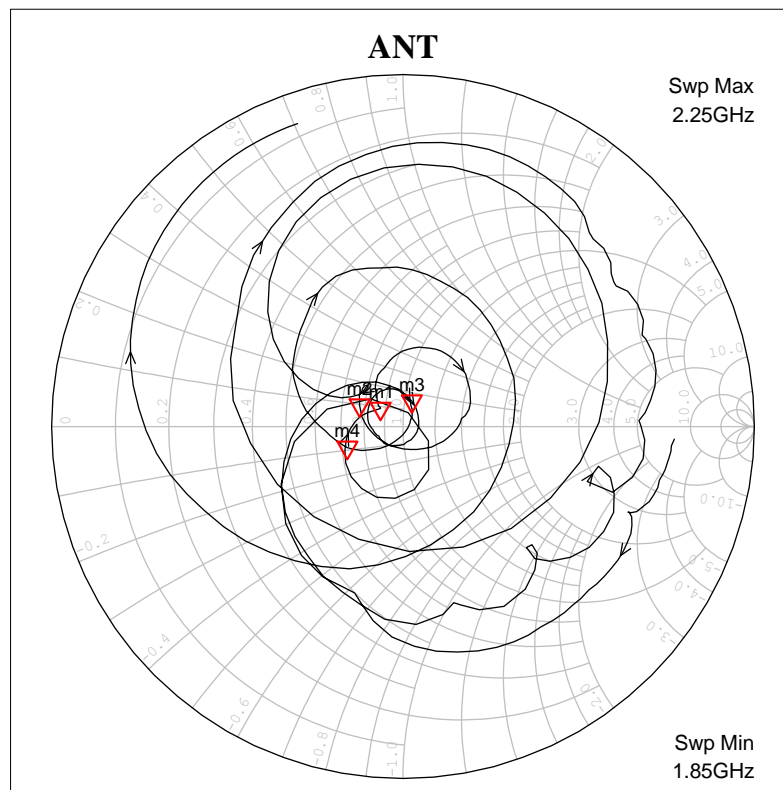

Tx Smithchart

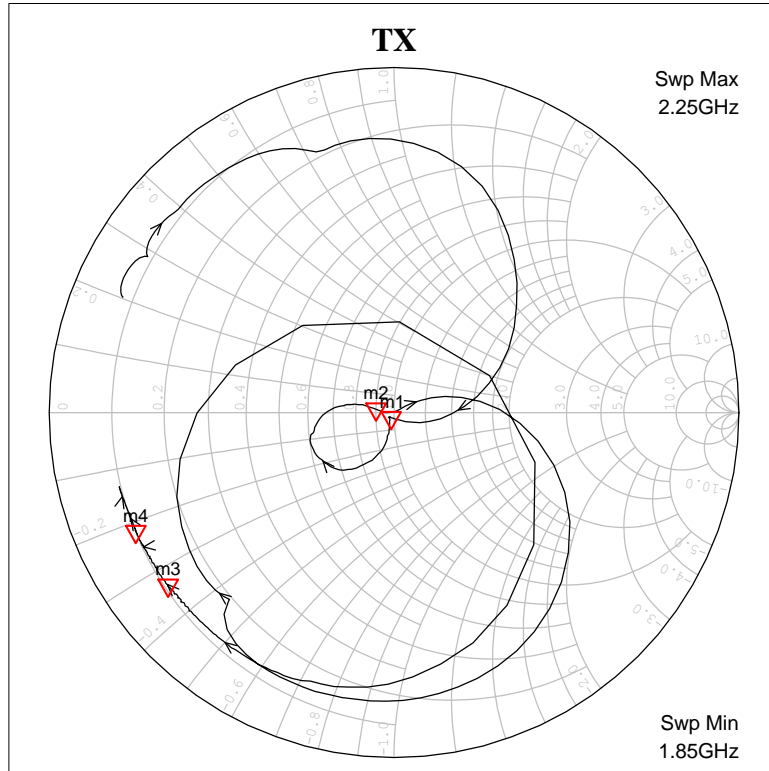

Rx Smithchart

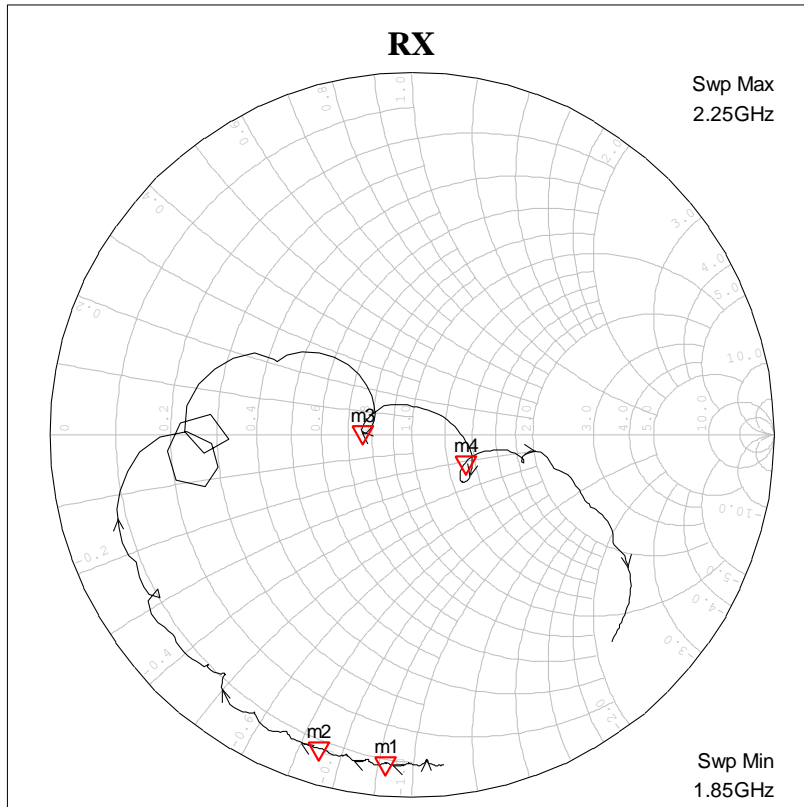

## 4. PACKING

### 4-1. DIMENSIONS

- Carrier Tape [Unit: mm]

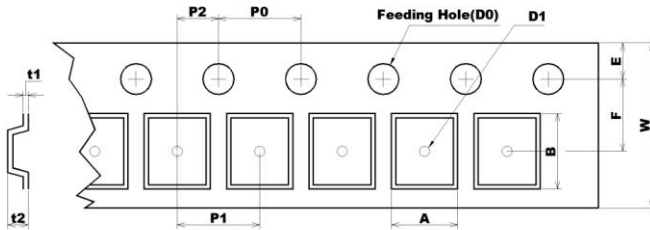

A	B	D0	D1
1.65	2.10	Ø1.50	Ø1.00
+ 0.05	+ 0.05	+ 0.10	+ 0.25
- 0.05	- 0.05	- 0.00	- 0.00
E	F	P0	P1
1.75	3.50	4.00	4.00
+ 0.10	+ 0.05	+ 0.10	+ 0.10
- 0.10	- 0.05	- 0.10	- 0.10
P2	t1	t2	W
2.00	0.254	1.00	8.00
+ 0.05	+ 0.02	+ 0.02	+ 0.30
- 0.05	- 0.02	- 0.02	- 0.10

- Reel [Unit: mm]

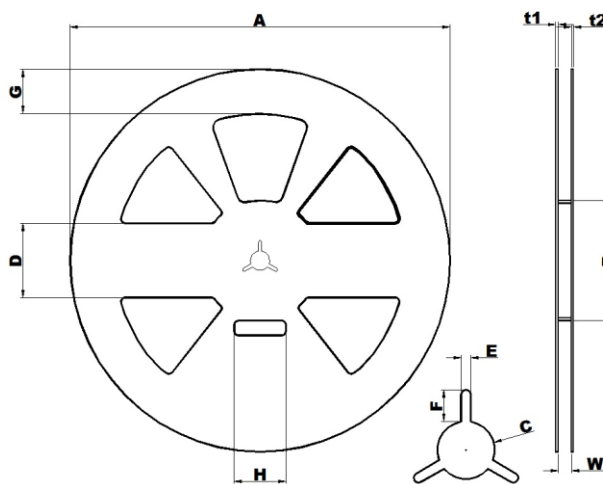

A	B	C	D
Ø258.0	Ø81.0	Ø13.0	50.0
+1.0	+1.0	+0.5	+0.8
-0.5	-1.0	-0.5	-0.8
E	F	G	H
2.2	7.0	30.0	35.0
+0.3	+0.5	+0.8	+1.0
-0.3	-0.5	-0.8	-1.0
t1	t2	W	
1.8	1.5	9.0	
+0.5	+0.5	+1.0	
-0.5	-0.5	-0.5	

- The product shall be packed properly not to be damaged during transportation and storage.

### 4-2. REELING QUANTITY

10 inch reel : 8,000 pcs/reel

### 4-3. TAPING STRUCTURE

The tape shall be wound around the reel in direction shown below.

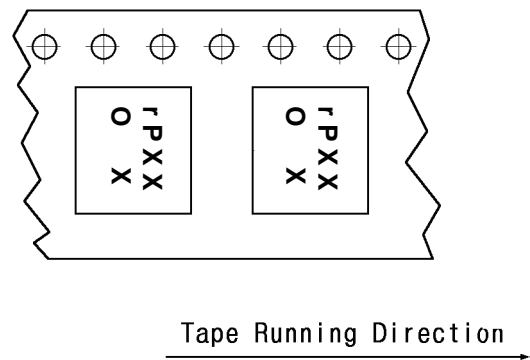
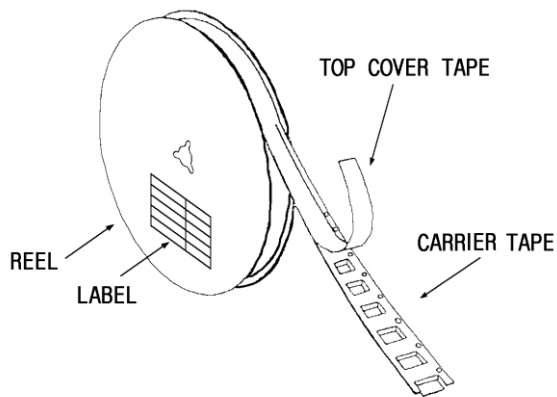

### 4-4. WEIGHT

7mg/EA