

Data Sheet

- ITEM : COMMON MODE FILTER

- PART NO : ICMF112P120MFR

- CONDITION : 1. _____
2. _____
3. _____
4. _____

ITEM	P/N	Page
Common Mode Filter	ICMF112P120MFR	2

1. GENERALS

- This specification covers the engineering requirements for the ICMF112P120MFR (Common Mode Filter)

2. FEATURES

- Effective for suppressing common mode noise and almost no effect for high speed differential data line
- Ultra low profile (1.27 x 1.0 x 0.6mm)
- Ceramic multilayer type SMD component
- Non-polarized product
- It is a product conforming to RoHS directive.

3. APPLICATIONS

- LVDS lines in notebook computers
- USB2.0, IEEE1394, DVI in PDP, LCD TV, DVD Player, PC, Audio player, DSC

4. PRODUCT SPECIFICATIONS

4. 1 PART NUMBER CODE

ICMF 11 2P 120 M F R
 ① ② ③ ④ ⑤ ⑥ ⑦

- ① Series name of ICT's Common Mode Filter
- ② Dimensions, 1.27mm (L) x 1.0mm (W)
- ③ The Number of lines, 2P = 2 lines
- ④ Common Mode Impedance (at 100MHz), 120= 12Ω
- ⑤ Tolerance of common mode impedance, M= ±30%
- ⑥ Type of electrode plating: F= Lead Free
- ⑦ Packing Type, R= Reel

4. 2 SPECIFICATION OF ELECTRICAL CHARACTERISTICS

Characteristics	Common Mode Impedance	Resistance	Insulation Resistance	Rated Current
symbol		R_{DC}	IR_{CR}	I_R
Units	Ω	Ω	$M\Omega$	mA
Test Condition	@100MHz	$25^{\circ}C \pm 2^{\circ}C$	10V	$25^{\circ}C \pm 2^{\circ}C$
Value	12($\pm 30\%$)	Max 4.0	Min 10	Max 100

- Impedance Curves

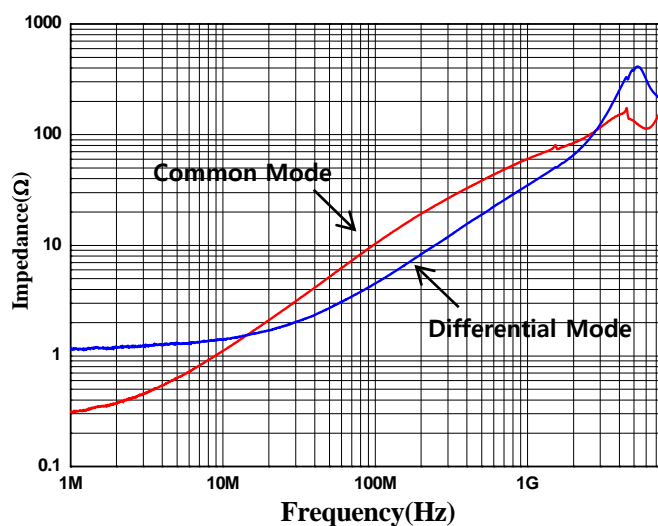

- Transmission characteristics (S-parameter)

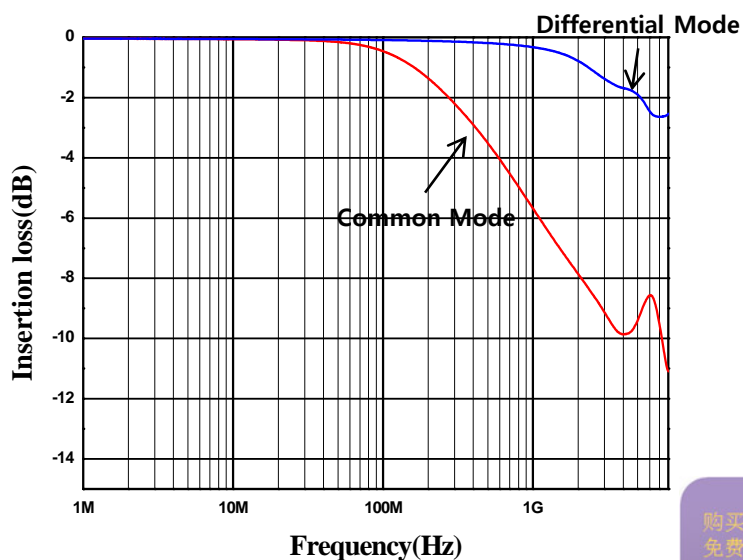

购买原装正品请认准-德方电子
 免费服务热线: 400-655-8700
 深圳总部电话: 0755-28187877
 网址: www.denovcn.com

ITEM	P/N	Page
Common Mode Filter	ICMF112P120MFR	4

4. 3 OPERATING TEMPERATURE

DESCRIPTION	REQUIREMENTS
Operating Temperature	-40°C ~ + 85°C

5. Equivalent Circuit & Recommended Foot print & Stencil Mask

Unit : mm

Stencil Mask T : 0.10mm

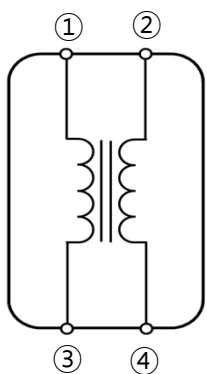

[EQUIVALENT CIRCUIT]

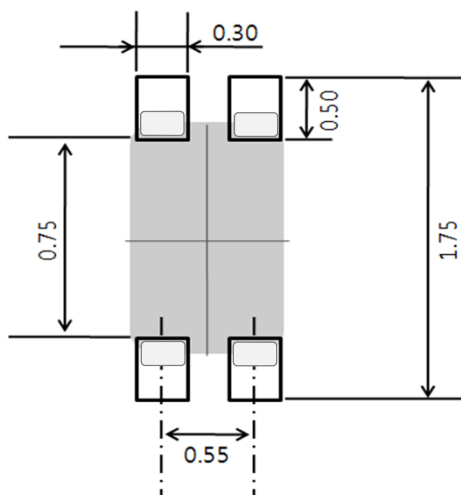

[Foot print]

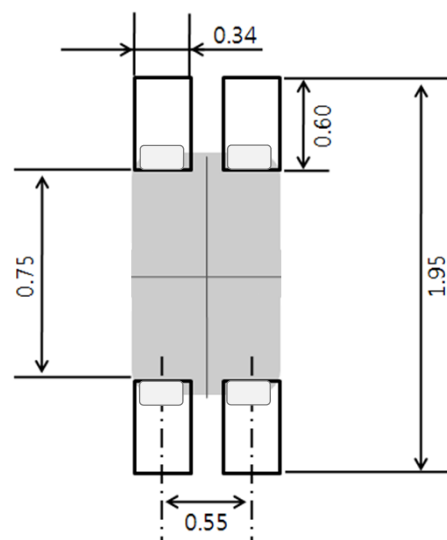

[Stencil Mask]

6. MECHANICAL PROPERTY

6. 1 Appearance and Dimension

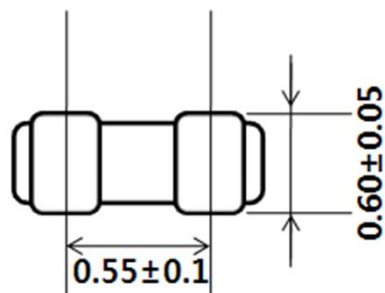
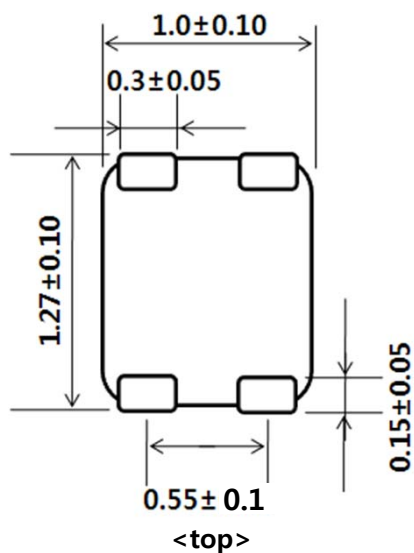

<side>

购买原装正品请认准-德方电子
 免费服务热线: 400-655-8700
 深圳总部电话: 0755-28187877
 网址: www.denovocn.com

Unit : mm

ITEM	P/N	Page
Common Mode Filter	ICMF112P120MFR	5

7. TEST METHOD OF ELECTRICAL PROPERTY

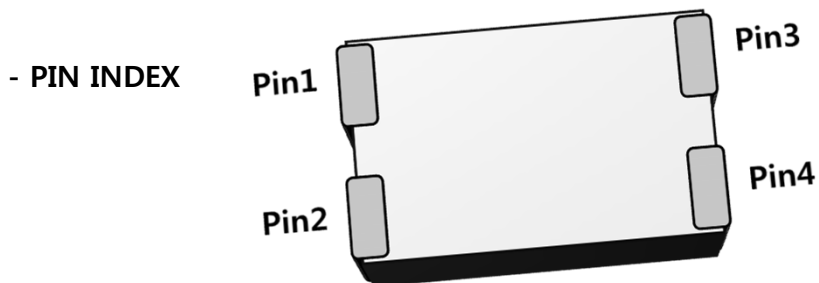

ITEM	DESCRIPTION	SOURCE	EQUIPMENT
Rdc	Pin 1 to 3, 2 to 4	10mA DC Source	Source Meter
CM Impedance	Pin 1-2(Short) to Pin 3-4(Short)		LCR Meter (3GHz)

7. 1 Rdc (Model: KEITHLEY 2400)

- Off power and On power.
- Press button 'Ω' of MEAS.
- Measure Rdc value using test fixture.

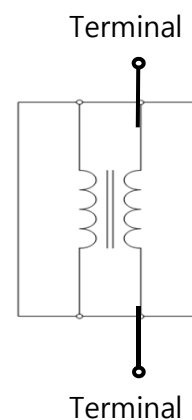
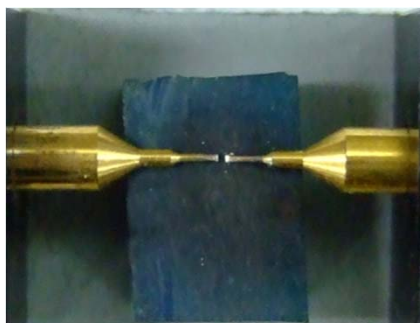

7. 2 Common Mode Impedance (Model: Agilent 4287A)

- Calibrate equipment
- Measure CM Impedance (at 100MHz) using test fixture.

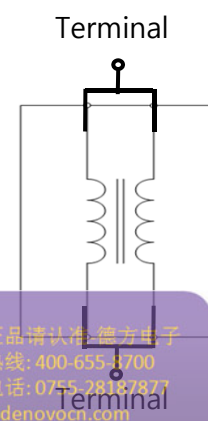
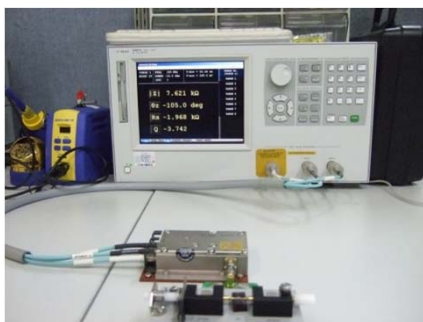

购买原装正品请认准：德方电子
 免费服务热线：400-655-8700
 深圳总部电话：0755-28187877
 网址：www.denovocn.com

8. REFLOW CONDITION

8. 1 RECOMMENDED SOLDERING PROFILE (Lead-free condition)

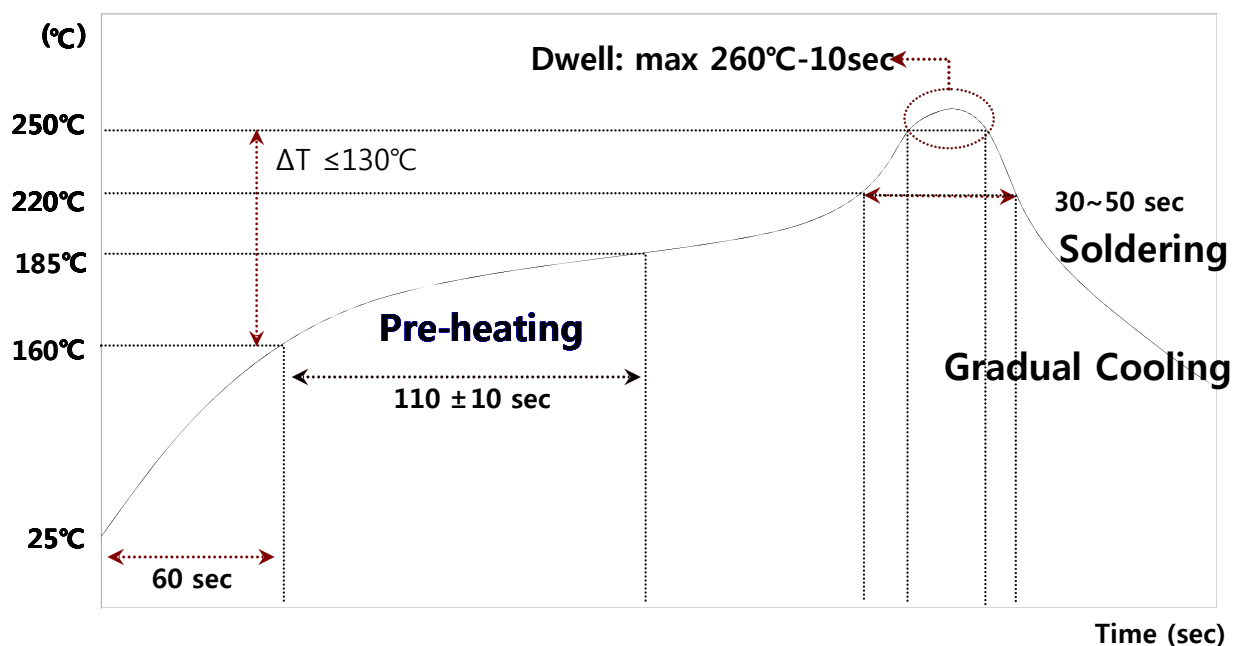

8. 2 RECOMMENDED LEAD-FREE SOLDER PASTE

- Supplier : Tamura Donghwa
- Main composition : Sn-Ag-Cu
- Ratio of composition : 96.5%-3.0%-0.5%

8. 3 RECOMMENDED HAND SOLDER

- Max Temperature: Max 380 °C(Max 5sec)

9. PACKING SPECIFICATION

9.1 TAPING FIGURE

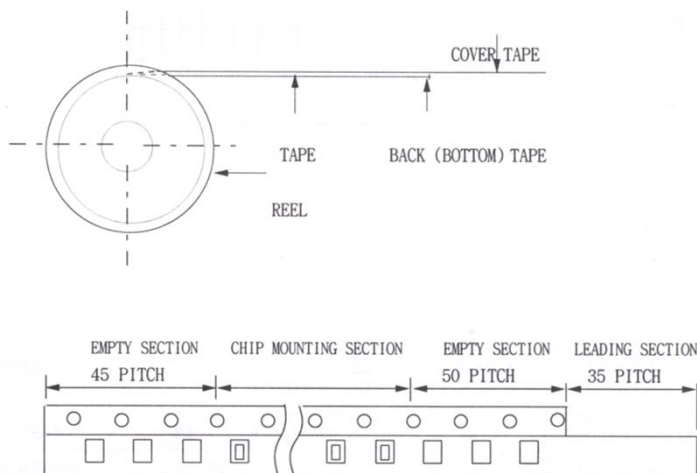

9.2 CARRIER TAPE DIMENSIONS

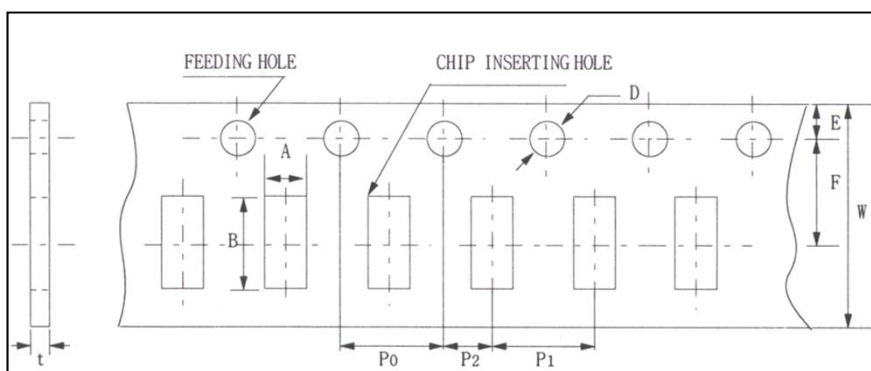

Unit : mm

SYMBOL	A	B	W	F	E	P ₁	P ₂	P ₀	D	t	
DIMENSION	11	1.15 ±0.05	1.5 ±0.05	8.0 +0.30 -0.10	3.5 ±0.05	1.75 ±0.05	4.0 ±0.10	2.0 ±0.05	4.0 ±0.10	1.55 ±0.03	0.75 ±0.05

ITEM	P/N	Page
Common Mode Filter	ICMF112P120MFR	8

9. 3 REEL DIMENSIONS

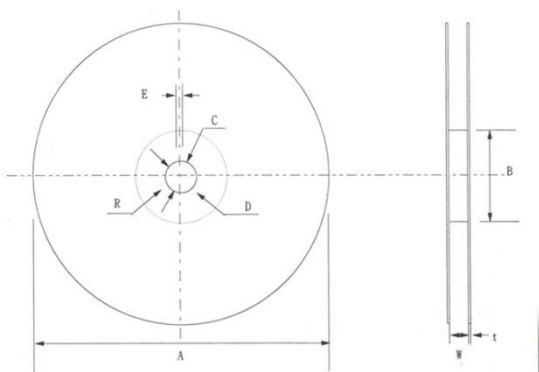

- (1) Reel Materials: Polystyrene
- (2) Label
- (3) Taping
 - Standard Packing Quantity per Reel ($\phi 178$)
 - Paper Tape: 4,000pcs

Unit : mm

CODE	A	B	C	D	E	W	t	R
DIMENSION	$\phi 178 \pm 2$	Min. $\phi 50$	$\phi 13 \pm 0.5$	$\phi 21 \pm 0.8$	2.0 ± 0.5	10 ± 1.5	0.8 ± 0.2	1.0

9. 4 LABEL CODE

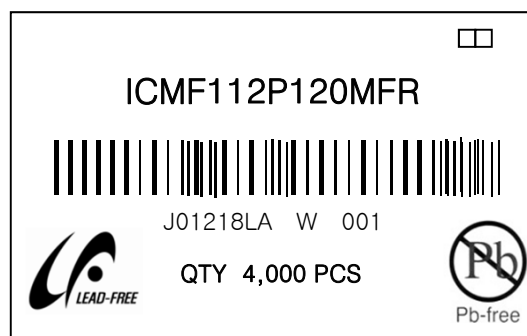
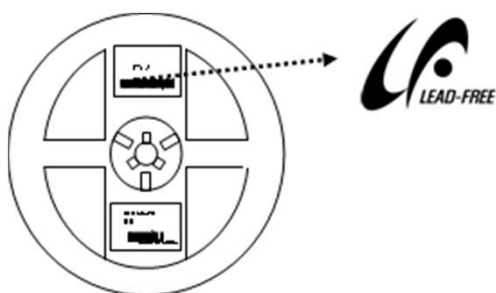

- P/N : Part Number
- L/N : Lot Number
- C/N : Customer Number
- SPEC : Size, Line numbers & CM Impedance
- DATE : Date code
- Q'TY : Quantity

购买原装正品请认准-德方电子
 免费服务热线: 400-655-8700
 深圳总部电话: 0755-28187877
 网址: www.denovcn.com

ITEM	P/N	Page
Common Mode Filter	ICMF112P120MFR	9

9. 5 REEL PACKING

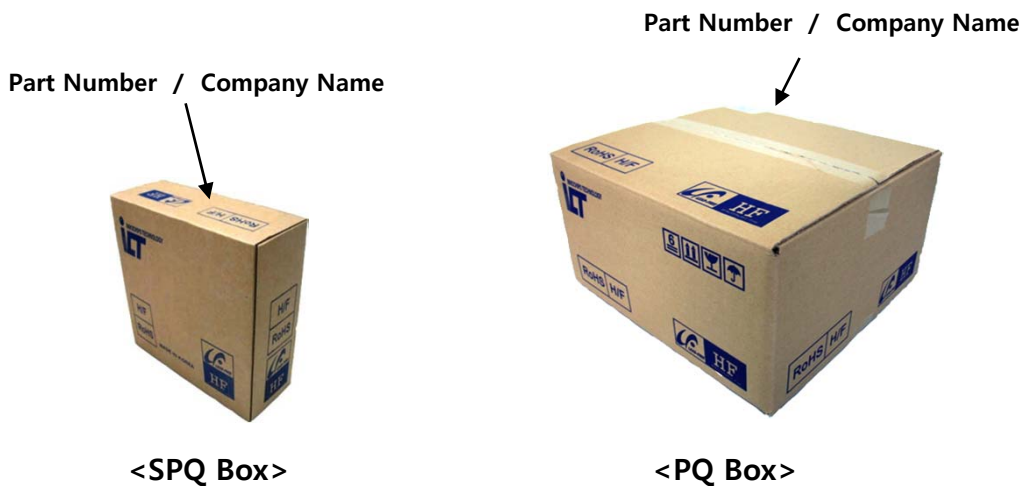

- Product box material : Card board
- 5 Reels in each SPQ Box
- PQ Box contains 10 SPQ Boxes (50 Reels)

Packing box + Product weight

Size			S-box + 5reel		M-box + 5S-box		L-box + 10S-box	
Product	L x W x H(mm)		185 x 70 x 185		370 x 190 x 200		380 x 370 x 200	
	Size	weight(g) /1 unit	Total(g)	Chip(g)	Total(g)	Chip(g)	Total(g)	Chip(g)
CMF	0806	0.00124	643	62	3215	310	6147	620
	1210	0.00480	750	96	3758	480	7503	960
	2012	0.00750	804	150	4028	750	8043	1500
CMEF	0806	0.00128	646	65	3230	325	6177	650
	1210	0.00490	752	98	3768	490	7523	980
	2012	0.00760	806	152	4038	760	8063	1520